

Timing Cache Accesses to Eliminate Side Channels in Shared Software

Divya Ojha and Sandhya Dwarkadas

Department of Computer Science, University of Rochester
{dojha,sandhya}@cs.rochester.edu

Abstract—Timing side channels have been used to extract cryptographic keys and sensitive documents, even from trusted enclaves. In this paper, we focus on cache side channels created by access to shared code or data in the memory hierarchy. This vulnerability is exploited by several known attacks, e.g, evict+reload for recovering an RSA key and Spectre variants for data leaked due to speculative accesses.

The key insight in this paper is the importance of the first access to the shared data after a victim brings the data into the cache. To eliminate the timing side channel, we ensure that the first access by a process to any cache line loaded by another process results in a miss. We accomplish this goal by using a combination of timestamps and a novel hardware design to allow efficient parallel comparisons of the timestamps. The solution works at all the cache levels and defends against an attacker process running on another core, same core, or another hyperthread. Our design retains the benefits of a shared cache: allowing processes to utilize the entire cache for their execution and retaining a single copy of shared code and data (data deduplication).

Our implementation in the GEM5 simulator demonstrates that the system is able to defend against RSA key extraction. We evaluate performance using SPEC CPU2006 and observe overhead due to first access delay to be 2.17%. The overhead due to the security context bookkeeping is of the order of 0.3%.

1. Introduction

Shared memory resources expose timing side channels that can reveal information even in the presence of security measures such as process isolation and enclave separation. Cache side channels leveraging shared software have been shown capable of extracting cryptographic keys, sensitive documents, and data even from cryptographically secured enclaves [5].

In this paper, we focus on cache side channels created by access to shared software in the memory hierarchy. Shared software is an essential component to keeping system costs low. For instance shared libraries (code) are an important optimization in modern computing systems to help keep the memory footprint low. Likewise, services providing access to large data stores result in data being shared across untrusted client requests. Access to the shared code or data leaves a footprint in the memory

hierarchy, which has been exploited by several known attacks [34] [12] [21] [32] [10] [5] [17].

A typical cache side channel attack when sharing software involves evicting the shared data (e.g., code from a shared library) from the cache hierarchy and re-accessing it after the victim’s execution (using evict+reload or flush+reload [32]). A fast re-access is indicative of an access to the shared location by the victim. If the shared library access is indexed by a secret data, the attacker can infer the victim’s secret. This attack model is used in attacks to leak cryptographic keys [32], in Spectre I, Spectre II [17], and NetSpectre [26], in cross-tenant attacks to leak data in clouds providing Platform-as-a-service [34], and in discovering key strokes [28].

In this work, we design and evaluate a low-overhead hardware-software solution to defend against attacks using shared software. Our key insight is recognizing the importance of the attacker’s first access to the data after a victim has brought the data into cache. We want to ensure that the first access by a process to any cache line loaded by a different process is a miss. In software, we save and restore the timestamp of when an execution context was last run. In hardware, we track cache line reload timestamps and propose a novel hardware design to allow efficient parallel comparison of a set of timestamps.

Prior solutions for eliminating cache side channels using shared libraries partition the cache [29] [22], which reduces the effective cache size for individual processes and does not provide security guarantees or cache side channel resistance on state-of-the-art partitioners [13] when data is shared across contexts. Other solutions protect accesses only to the LLC [20] [31]. Our goal is to retain the benefits of a shared cache by allowing each process access to the entire cache, and to protect every level of cache.

We create a “per-process view” of cache occupancy by delaying (treating as a miss) the first access to a cache line (i.e., a cache hit) that has been brought into the cache by a different process. Accesses beyond the first will be serviced as a hit. The delayed first access presents the process with the illusion of timing isolation from other processes. While there is share data between processes, the isolation is achieved by giving every process the impression that data is brought into the cache by its own access. This approach breaks the fundamental premise of attacks using shared software. The reduction in the performance due to

such delay can be considered elemental to the design of a secure cache while at the same time avoiding a potential $O(n)$ space consumption for n processes sharing data in a partitioned cache. Delay is incurred only when data is evicted and reloaded, so that the steady-state in-cache sharing is unaffected. As a consequence of this defense, systems can choose to deploy memory deduplication techniques to reduce memory footprint [15], [1] without the fear of creating an avenue for cache side channels through a shared software stack.

We propose and evaluate a timestamp-based cache access management system that combines novel hardware and software support to provide timing isolation. Each cache line is augmented with a “load-time” timestamp and a bit per hardware context representing whether the cache line has been accessed by the execution context. This bit is checked upon a cache hit and the request is serviced if the bit is set, otherwise a miss penalty is incurred and a request is sent down the memory hierarchy. Software saves (and restores) these bits along with the “context-switch” timestamp at a context switch. A novel *bit-serial* comparison logic allows for fast parallel “load-time” and “context-switch” timestamp comparisons.

We evaluate both the security and performance of our defense on the GEM5 simulator [4] and demonstrate its effectiveness against attacks using microbenchmarks and an RSA attack. Our defense is able to prevent the classic RSA attack used to demonstrate *flush+reload* attacks. Performance evaluation using SPEC2006 shows an average overhead of 2.17%, due to the delayed accesses. The overhead due to the security context bookkeeping is about 0.3%.

This paper makes the following key contributions:

- The insight that disallowing the first access by a process to a cache line from experiencing a cache hit when the cache line has been brought into the cache by a different process, is sufficient to prevent cache side channel attacks through shared software.
- A timestamp-based solution to creating a per-process view of cache line occupancy to prevent such attacks.
- A fast *bit-serial* comparison logic to compare timestamps for all the cache lines simultaneously.
- A simulation-based evaluation of the potential overheads of timing isolation and a demonstration that our proposed solution prevents real-world attacks.

2. Background

2.1. Cache Side Channels

Information leaked as a result of shared cache utilization is collectively referred to as *cache side channels*. Mechanisms to exploit cache side channels were first exposed as early as in 1992 [14], and different classes of attacks relying on cache access timing have been developed since then.

Two types of information leaks are possible depending on whether or not there is shared memory between the attacker and the victim. With no shared memory between the

Figure 1: Shared Library Attack in Cache

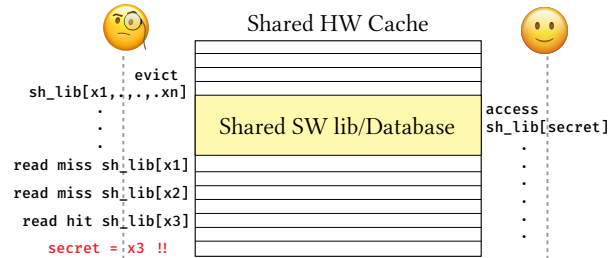

attacker and the victim, the attacker can only learn the cache set accessed by the victim using a “Prime+Probe” style of attack [6]. In the presence of shared software, an attacker can learn the line accessed by the victim using an “evict+reload” or “flush+reload” style attack [32], [11]. Defenses against “prime+probe” attacks such as caches using randomized placement [23] [19] are not effective against “evict+reload” or “flush+reload” style attacks. The latter is a low-noise, high-bandwidth, and more efficient form of attack. This work addresses this second style of attacks.

2.2. Shared Library Attacks

Shared libraries have commonly used subroutines, which can be mapped directly into the user program. The same physical memory is mapped into different processes’ virtual address spaces. Shared libraries are used to reduce memory footprint and improve memory hierarchy efficiency. However, they create the potential for leaked memory access patterns through cache side channels.

Side channels using shared libraries were earlier assumed to affect only cryptographic routines. The advent of more recent attacks have shown that they are a handy gadget for more sophisticated attacks like Spectre [17][26][18]. They are also capable of leaking keystrokes from another process [28], leaking passwords in cloud environments such as an Amazon EC2 server, and leaking data across Virtual Machines [34].

2.3. Threat Model

The threat model under consideration has a separate attacker and victim process sharing some software stack. They could be running simultaneously on the same (hyperthreaded) or different cores, or interleaved in time, and the attack can be conducted from any level of the cache. The attack is as shown in Figure 1 and has the following sequence:

- 1) The attacker and victim share a software library and a hardware cache. The access to the shared library is dependent on or is indexed using the victim’s secret data.
- 2) The attacker evicts a shared location from the cache hierarchy.

- 3) It then waits for the victim’s execution.
- 4) The attacker subsequently reloads the same shared location and determines that the shared location was also accessed by the victim if it hits in the cache, determined by timing the access.

This attack model is self-sufficient in the sense that it has been demonstrated to be capable of leaking RSA keys when using the GnuPG shared library [32], [12]. It is also a low-noise, high-bandwidth tool for building more sophisticated attacks like Spectre-I & II, SpectreRSB [18], and Netspectre [26]. Each of these more recent attacks rely on leaking shared library access patterns through cache side channels and depend on a fast reload preceded by an eviction.

2.4. Goal & Insights

The potential scope of cache side channel exploits include those devised in Spectre-style attacks based on speculation [17] and is not limited to specific application domains such as cryptography. Hence, domain- or attack-specific solutions are not sufficient.

The goal of this work is to design a cache that allows processes to reap the benefits of sharing both cache and data without leaking access pattern information via timing side channels. Preventing information leak requires identifying and slowing down the first access to data present in the cache but brought in by a different process. As a consequence of this design, systems can choose to deploy memory deduplication techniques to reduce memory footprint [15], [1] without fear of creating an avenue for a reuse-based covert channel attack.

3. Per-Process Cache Line Visibility

The goal of our design is to eliminate cache side channels through shared memory while retaining the benefits of memory sharing: reduced bandwidth and energy consumption for data movement and reduced space consumption in the cache. Every process should see its *first access* to a resident cache line that it did not bring in with a delay equivalent to a miss in the cache. Once a cache line has been accessed by a process, its subsequent accesses to the data from the same cache line are allowed to go through as a hit (presuming the data has not been evicted). This allows different processes to share access to the same cache line without revealing to one another if the cache line was made available in the cache by another process. Compared to the solutions that rely on cache partitioning (example, Intel’s cache allocation technology [20]), this approach does not restrict the size of usable cache for any process. It is also applicable to any level of the cache including L1 and LLC.

3.1. First Access

A process’s *first access* refers to its first access to an existing cache line that has been brought in due to access

by another process. It does not refer to the first usage of a certain data in a program (commonly referred to as *cold*). A cache line can have as many first accesses as the number of processes accessing it. If a cache line is evicted and later brought back by a process, it is considered unaccessed by other processes.

The importance of the *first access* lies in the construct of the attack. If the attacker times its *first access* after evicting a data from the cache hierarchy and is able to detect a cache hit, the attacker is able to infer the victim’s memory access patterns. Beyond the first access, a fast access or a cache hit does not provide any clue about the data access pattern of another process. Based on this key observation, the defense works by disallowing fast first accesses.

3.2. Timestamp-Based Design

We propose and evaluate a timestamp-based cache access management system that combines novel hardware and software support for timing isolation. Our design is based on the observation that the attack under consideration exploits the caching benefits due to another process. The attacker evicts the shared memory and expects its subsequent access to be fast if the victim has accessed the same shared memory location. Hence we propose to identify and delay the *first access* of a process, so the attacker is unable to infer whether the memory was cached beforehand. Subsequent accesses by the process proceed as a cache hit. Figure 2 provides an overview of the hardware modifications.

Each cache line is augmented with a “load-time” timestamp to store the time at which the line was loaded. An additional bit (security bit or *sbit*) per hardware context represents whether the cache line has already been accessed by the context. When a cache line is loaded, the *sbit* for the loading context is set and the *sbits* for all other hardware contexts are reset. For a cache hit, the *sbit* of the accessing context is checked. When the *sbit* is set, the access is allowed to proceed as a hit. Otherwise the access is recognized as a *first access* and delayed, and the *sbit* is set so that the future accesses can proceed as a hit. Accesses are delayed by sending the request down the memory hierarchy but not filling the cache with the received data. This mechanism is implemented at every level of cache in the memory hierarchy.

The *sbit* save and restore can be done by any trusted computing base library at the time of context switch. In our implementation, we allow the OS to save and restore the process-specific *sbits*.

In order to retain caching behavior at context switch and still provide timing isolation, software saves the *sbits* for the context along with the “context-switch” timestamp (*Ts*) at a context switch. Software also restores the *sbits* to the cache in the corresponding hardware context when the process resumes execution.

```
/*at context switch*/
restore_sbits();
if (Ts<Tc)
```

Figure 2: Timestamp-Based Cache Access

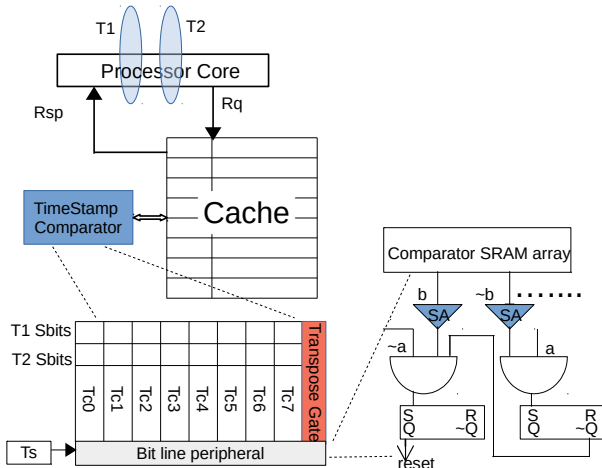

```

reset sbit;
/*memory access*/
if (cache_miss)
    request_mem;
    handleFill;
    sbit=1;
else if (cache_hit)&(sbit==0)
    request_mem;
    no_handleFill;
    sbit=1;
/*cache line replacement*/
if (line_evicted)
    for_all_threads:
        sbits = 0;

```

An *sbit* reset is required when T_s is older than the line’s “load-time”. A novel *bit-serial*, timestamp-parallel comparison logic allows fast parallel “load-time” and “context-switch” (T_s) timestamp comparisons. The details of the implementation are described in Section 4.

In Figure 2, we show a cache consisting of 8 cache lines accessed by two hardware contexts. The hardware support added to a conventional cache is as follows:

- A bit-serial, timestamp-parallel comparison logic with transpose gate and bitline peripherals, to compare timestamps efficiently.
- A per cache line, per hardware context bit (security bit or *sbit*).
- A shift register to hold T_s , the timestamp indicating the time when the process last executed, for the process about to begin execution due to a context switch.

Our design leverages the benefits of caching across context switches as long as a cache line is not evicted. Two processes running in an interleaved fashion and accessing the same memory location will continue to enjoy fast access as long as the data is not evicted from the cache. After each eviction, each process will individually see a delayed *first access*. Hence, our design leverages locality across context

switches while providing timing isolation, something that cannot be achieved by simply flushing the cache on a context switch. The mechanism described here is a processor feature which can be turned off if the processes are trusted and cache attacks are not a concern.

4. Implementation

The following subsections describe the implementation details of each hardware modification and the software support required for the defense.

4.1. First Access Delay Mechanisms

On a traditional cache access, data is returned to the processor if a tag and state lookup succeeds. Otherwise, the access incurs a miss and the request is passed on to the next level in the memory hierarchy. With our cache design, the *sbit* for the cache line is checked in addition to the state and tag bits. An access is considered a hit only if in addition to the above, the *sbit* of the cache line is set, in which case data is returned to the processor from the cache.

A reset *sbit* indicates that the current process has not accessed the cache line. If the *sbit* is reset, the response to the processor is delayed by sending the request up the memory hierarchy. Once the response is received, the received data is discarded, and the data in the cache line is forwarded to the processor. The *sbit* is set to ensure that future accesses to the cache line by the process do not result in additional traffic and are treated without additional delay.

The rationale behind sending a request down the memory hierarchy even when the data is available in the cache is to make the *first access* see a response latency equivalent to the variable access latency it would have incurred on a miss. It is possible that a context’s *sbit* is reset in a higher-level (closer to the processor) cache but set in a lower-level cache due to its larger capacity. Sending a request down the memory hierarchy ensures that if the requested data is available in a lower-level cache and has the *sbit* set, the request is serviced with the lower cache response latency. The data received in the response is, however, discarded, as the cache has the most recent copy of the data.

When a cache line is evicted or invalidated, all *sbits* are reset. When a cache line is loaded, the *sbit* for the hardware context loading the line is set; the *sbits* for all other hardware contexts sharing the cache remain reset.

On a context switch, T_c for each cache line is compared against T_s (loaded into a special register by software) for the context being resumed; the *sbits* for lines that have T_c greater than T_s are reset to enforce delayed first access.

Thus, the *sbit* state is changed as follows:

- Reset when a process is first initialized
- Reset by the timestamp comparison logic when the process is scheduled
- Reset when a cache line is evicted or invalidated
- Set for the requesting hardware context when a cache line is loaded; reset on all other hardware contexts

Figure 3: Cache Access Flow Chart

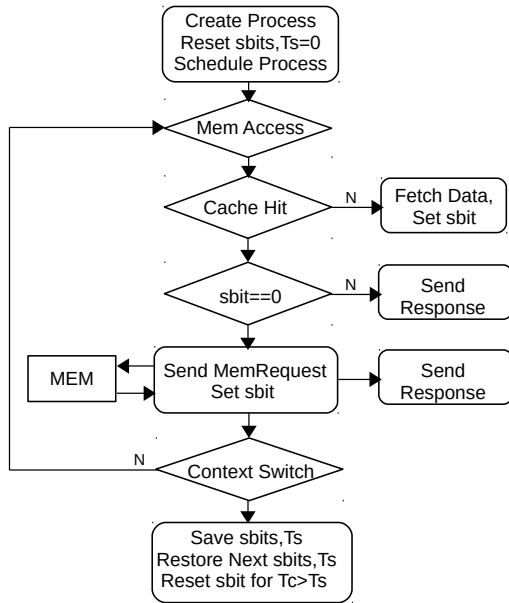

- Set for the requesting hardware context after a first access to a previously loaded cache line

Software saves and restores the *sbits* for a process executing on a hardware context at the time of a context switch. Additionally, software maintains T_s for each process, which is the time the process was most recently preempted. A newly created process has both T_s and *sbits* reset when it is scheduled for the first time.

The flow chart in Figure 3 represents the sequence of events on a cache access and the required bookkeeping at context switch.

4.2. Per-Process *sbits* Copy and Update

The *sbits* are saved and restored on a context switch to preserve caching benefits across context switches. If the *sbits* were not saved and instead reset on every context switch, this would be equivalent to flushing the cache on every context switch, which can impact performance heavily [7].

The number of 64-byte (cache line size) memory accesses required to save or restore *sbits* is dependent on cache size. A small 64KB L1 cache requires only 2 64-byte memory accesses, while a larger 8MB L3 cache requires 256 64-byte memory accesses.

Restored *sbits* cannot be used as is since they are stale and need to be updated based on any changes in the cache. If a cache line is evicted while a process is preempted, its corresponding saved *sbit* in memory will not be up-to-date. To update the *sbits* for cache lines that might have been evicted, invalidated, or reloaded when the process was preempted, we use the T_s timestamp. T_s indicates the last time the *sbits* were brought up-to-date, so any cache lines loaded after that time would not have been accessed by the

Figure 4: Transpose SRAM Array for Timestamps

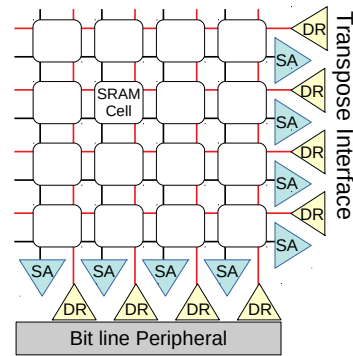

process. When a process resumes execution, its restored T_s is compared with the T_c of every cache line in parallel, and the *sbits* for all cache lines with T_c greater than T_s are reset. Timestamp comparisons are triggered *only* at the time of a context switch and prior to resuming a process. Subsequent accesses need no comparison since the *sbits* now contain the necessary information.

We discuss the comparison of T_c and T_s , and the mechanism for updating large arrays of *sbits* in constant time (proportional to the number of T_c bits) in the following subsection.

4.3. Bit-Serial, Timestamp-Parallel Comparison of Timestamps

A regular data access from memory is *bit-parallel*, i.e., all the bits of a word are accessed at a time. Accessing SRAM arrays in *bit-parallel* fashion implies that the time required would be proportional to the number of cache lines. In order to perform parallel comparisons of cache-line timestamps (T_c) and T_s , we store the per cache-line T_c timestamps along with the cache-line's *sbits* in an SRAM array in a transposed fashion, similar to that proposed in the neural cache work [8]. The result is computation performed in a *bit-serial* [3] and word-parallel (timestamp-parallel) manner.

The transpose memory unit [8] uses 8-T bit cells and two sets of sense amps and drivers to access data in both regular and transposed modes. While access times will be higher compared to a 6-T SRAM cell, accesses can be made in parallel with the much larger cache data arrays. Figure 4 shows the timestamp array and comparison logic, constructed with the 8-T multi-access SRAM cells. The 'transpose interface' is used for the regular operation of the cache, which is when timestamps are updated and *sbits* of other contexts are reset, or an *sbit* needs to be looked up or set. The 'regular' bit-line peripheral interface is used for *sbit* saves and restores, as well as for parallel timestamp comparisons and *sbit* resets.

After the process-specific *sbits* are loaded into the SRAM array in the *sbits* for the corresponding hardware context, they need to be updated with the information about

the cache lines that have been evicted while the process was preempted. This is done by comparing the T_c and the restored T_s . The transposed timestamps allow a *bit-serial* and timestamp-parallel comparison, taking time linear in the number of bits in the timestamp (32 in our experiments). The logic required for the timestamp comparisons and reset of *sbits* is shown in Figure 5.

4.3.1. Bit-Serial Comparison Logic. Bit-serial computation allows us to simplify the comparison logic. The greater of two unsigned integers can be determined by comparing their bits sequentially starting from the MSB (most significant bit): one of the two numbers can be declared as larger when the first bit that differs is encountered: the larger number will have the bit set in its binary representation where the other number has the bit set to 0. We codify the above algorithm in the following scheme iterating from the MSB:

- If the bit position under consideration has a 1 for only one of the two numbers, that number can be marked as greater and the comparison is complete. This behavior can be checked by performing an xor of the two bits.
- If the bit position under consideration has a 0 for both the numbers, the next bit position is considered.
- If the bit position under consideration has a 1 for both the numbers, the next bit position is considered.

For instance, the greater of the two numbers ‘1100’ and ‘0101’ can be determined as the first number ‘1100’ by looking at the MSB.

T_s is loaded into a shift register. For each of 32 iterations (the size of our T_c timestamp), the T_c timestamps are read from the SRAM array 1 bit at a time using the ‘regular’ bit-serial peripheral interface, at the same time as the shift register is shifted left to feed the comparison logic.

- If $T_c[i]$ is 0 and $T_s[i]$ is 1, $T_c < T_s$, the *sbits* need not be updated and the comparison should stop. We latch this output and use it to ignore further bit comparisons.
- If $T_c[i]$ is 1 and $T_s[i]$ is 0, $T_c > T_s$, i.e., the cache line is newer than the T_s . The bit-line peripheral latches a ‘1’ and the latch output is used as the reset for the *sbit*.

Figure 5 shows the peripheral circuit attached to each SRAM bitline. It requires 2 SR latches, which are reset prior to initiating the timestamp comparisons, and 2 3-input and gates for the comparison operation, with the T_c bit being fed to ‘b’ and the T_s bit to ‘a’.

The comparison should stop if the T_c is determined to be smaller than T_s , which is the result of the and gate on the right. To ignore further bit comparison, the result is latched using an S-R latch, and Q is fed to the and gate on the left.

At the end of the 32 iterations, if it is determined that $T_c > T_s$, as latched in the left-hand S-R latch, the bitline drivers for which the S-R latch has been set, and the wordline for the *sbit* corresponding to the hardware context, are enabled, to write a 0 into the *sbits*.

Figure 5: Bit-Line Peripheral

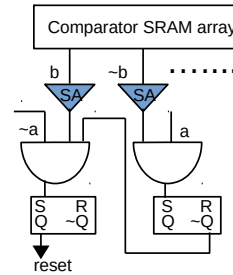

5. Evaluation

We implemented our defense in the GEM5 cycle-accurate simulator [4] using L1I and L1D caches of 32KB each and an L2 (LLC) cache of 2MB. We added a timestamp and a per-hardware-context sbit to each cache line, which are manipulated as described in Section 3.2. The process context for a request packet in the cache is determined by the CR3 register within the simulator. Changes in the CR3 register are used to trigger the timestamp comparisons and the *sbit* saves and restores.

Table 1 specifies the real and simulation system parameters used for the evaluation.

TABLE 1: Evaluation Setup

Real Processor	
Core	i7-7700, 3304.125
L1D, L1I, L2, LLC cache	32K, 32K, 256K, 8192K
GEM5 Simulator	
Core	TimingSimpleCPU, 2GHz
L1D, L1I, LLC cache	32K, 32K, 2048K

The following subsections present an analysis and evaluation of the security and the performance overheads of our timestamp-based defense on the GEM5 simulator.

5.1. Security Analysis

The attack depends on a fast reload due to another process. If no process is allowed a cache hit due to another process, the attack can be broken. If the *first access* is never a cache hit, the attacker remains oblivious of the data being cached beforehand and cannot learn if some shared data was accessed by a victim. There is no channel left for the information leakage using shared memory. The second access is of no significance to the attacker. Allowing unaltered access beyond the *first access* is sufficient to ensure security while not significantly compromising performance. The additional information tracked for the defense includes timestamps and the *sbits*, are saved and restored by trusted software, and are protected from unprivileged access. The *sbits* are not shared across execution contexts and their access does not leak any side channel information since they are not contingent on *sbit* values.

5.1.1. Microbenchmark functionality evaluation. In order to confirm the correct operation of the timestamp-based approach, we created a microbenchmark attack consisting of a pair of child and parent processes accessing a shared memory-mapped array of size equal to 256 cache lines. The parent process acts as the attacker, i.e., flushes the shared array and yields the processor. The victim’s execution follows, where it writes a value repeatedly to the shared array. The parent process then wakes up and performs timed reads of the entire array. A hit is considered a successful attack. The attacker does not see any hit with our defense simulation enabled in GEM5.

```

if parent
    flush shrd_mem;
    sleep;
    read shrd_mem; // cache hit
else
    read shrd_mem;

```

5.1.2. Attacking RSA. We use the flush+reload technique to attack the GnuPG version of RSA, as described in the original paper [32]. The attack was tested both on real hardware and the GEM5 simulator, both running Linux. The attacker is an independent program, sharing the same machine and hence the caches.

On a real machine, we install a non-stripped GnuPG library and locate the offsets for the Square, Multiply, and Reduce functions. The shared library has the encryption algorithm for exponentiation, which performs a sequence of Square-Reduce-Multiply-Reduce for processing a key bit value 1 and a sequence of Square-Reduce when processing a clear bit. RSA encryption is an example where the control flow through the shared library is indexed using secret information, i.e., in this case, bit values from the secret key.

In the original attack, the attacker flushes the cache and then accesses the memory location for the Square, Multiply, and Reduce functions in a loop, using the time to process a 1 or 0 bit coupled with whether or not accesses hit in the cache to extract information about the key being used. In our evaluation, we simplify the attack and assume a cache hit in the attacker process represents a successful attack.

We calculate the time required for a cached and uncached access on the experimental real machine and set that as the threshold for the cache hit. The attacker program is an independent program running a loop to flush and read memory. Reading the timestamps must be fenced/ordered with respect to the memory access being timed to avoid speculative loads. The attack goes through, i.e., the independent attacker program gets hits for its accesses as a simultaneously running victim process performs an encryption. We are able to launch the attack both on a real machine and in GEM5 *full-system* emulation mode.

Our defense in GEM5 disallows any cache hit in the attacker process since the attacker’s timed access is preceded by a flush. The defense allows a cache hit in a process only if it has suffered a cache miss for its *first access*. Since the access after the flush to a cached data is the *first access*,

which is delayed, the attacker does not perceive a hit. This attack was the key demonstration for the flush+reload attack and our defense successfully breaks the attack.

5.2. Performance Evaluation

5.2.1. First Access Delay. We evaluate the performance overhead of our first-access delay mechanism by running SPEC CPU2006 benchmarks in system-emulation mode. The benchmarks are run for 1 billion instructions and we record the overall increase in execution time (Figures 6a and 6b).

The number of first accesses when running a single benchmark on a single core are impacted by sharing both benchmark-specific code and shared libraries, as well as due to the shared L1 cache. The performance overhead in Figure 6a is a graphical representation of the overheads due to misses on first accesses. The exact overheads are presented in Table 2. The lower miss rates with the defense are due to the increased number of total accesses to the LLC cache from the extra first access misses.

Figure 7 shows the ratio of *first accesses* to the total number of accesses at each cache level for different benchmarks. As can be seen, mcf, omnetpp, and perlbench have a higher fraction of first access misses, resulting in higher performance overhead as seen in Figure 6a. On the other hand, libquantum and wrf have a very low fraction of first access misses, so their performance is not impacted by the defense. An interesting observation is that both mcf and perlbench have higher fractions of first access misses in the last-level cache when run individually, and high overhead when run together. However, when they share the LLC cache with any other application, their effective first access misses are lower because of cache contention, resulting in a lower performance penalty. Both astar_perl and mcf_gromac also have lower effective first access misses due to capacity evictions when sharing the cache and hence lower overhead.

Figure 6b shows normalized execution time when running two different benchmarks simultaneously on two different cores. The average overhead with two benchmark workloads is 2.17%. The overlap in common accesses and hence first accesses are limited to shared libraries when different workloads occupy the last-level cache.

The benchmarks that have several processes accessing shared libraries have a higher overhead due to delayed accesses since the caching benefits are not fully leveraged from one process to another. Thus, benchmarks like perlbench and omnetpp, which simulate network workloads by spawning several processes and using shared libraries among the processes have a slowdown larger than single processor benchmarks like libquantum.

5.2.2. LLC Size Sensitivity Analysis. To analyze the sensitivity of our design to cache size, we evaluate the performance overhead with different LLC sizes (Figure 8). Since the bigger caches are expected to have lower eviction rates for the same workload, there are effectively fewer first accesses, resulting in a smaller additional delay. Hence, we see the performance overhead in bigger caches to be smaller.

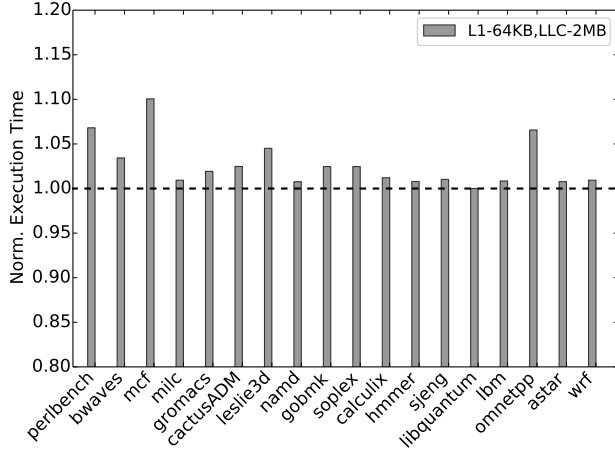

(a) Individual benchmarks

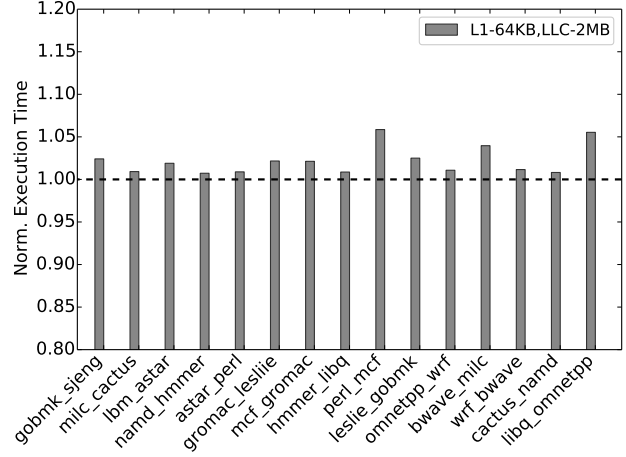

(b) Two benchmarks

Figure 6: Performance overhead due to delayed first accesses; The average overhead for single benchmarks is 2.2% and it is 2.17% for two benchmarks running together with L1 and LLC.

Figure 7: Delayed Access Miss Ratio at Each Cache Level

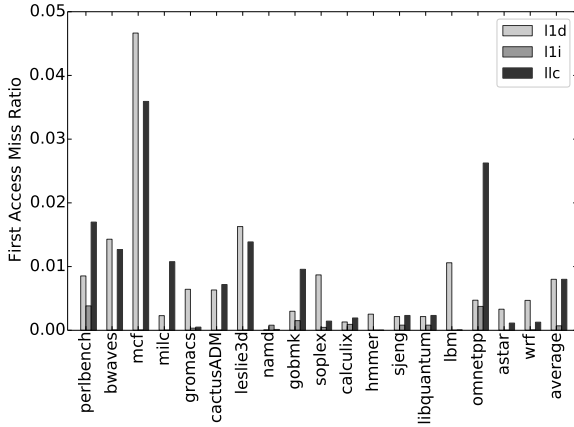

Our analysis with 2MB, 4MB, and 8MB LLC sizes has an average performance overhead of 2.5%, 1.6%, and 1.7%. The ratio of first access miss to the overall miss also varies inversely with the cache size. The first access miss to overall miss for the 2MB, 4MB, and 8MB cache sizes is 40%, 10% and 8% respectively. These numbers indicate that the defense scales well with larger caches.

5.3. Area Overhead and Scaling

The increase in area due to the additional hardware is primarily due to the separate SRAM array of timestamps and sbits, and the comparison logic. This separate SRAM array uses 8-T rather than 6-T cells and also includes an additional set of sense-amps and bit-line drivers. The other components required are the timestamp comparison logic at each bit-line peripheral, consisting of 2 latches and 2 3-input and gates and a shift register to hold Ts.

TABLE 2: SPEC2006 Execution Time Overhead, Miss Rate(%) LLC(2MB)

Workload	Overhead	MissRate Baseline	MissRate FA Miss
perlbench	1.068	8.35	7.65
bwaves	1.034	78.72	56.10
mcf	1.100	39.58	34.47
milc	1.009	66.55	65.03
gromacs	1.019	5.35	3.75
cactusADM	1.024	45.51	30.53
leslie3d	1.045	49.06	40.25
namd	1.007	6.81	4.50
gobmk	1.024	12.78	11.30
soplex	1.024	3.37	2.91
calculix	1.012	5.70	4.67
hmmmer	1.007	0.42	0.27
sjeng	1.010	72.67	62.96
libquantum	1.000	99.65	99.59
lbm	1.008	71.68	66.37
omnetpp	1.065	0.58	3.01
astar	1.007	2.77	2.32
wrf	1.009	25.83	22.39
Average	1.022	33.07	28.78
gobmk_sjeng	1.024	44.21	38.31
milc_cactus	1.009	65.72	56.34
lbm_astar	1.018	76.91	72.36
namd_hmmmer	1.007	3.74	2.48
astar_perl	1.008	9.68	8.11
gromac_leslie	1.021	45.23	36.45
mcf_gromac	1.021	36.10	30.51
hmmmer_libq	1.008	74.31	65.91
perl_mcf	1.058	27.94	23.29
leslie_gobmk	1.024	43.98	36.62
omnetpp_wrf	1.010	8.32	9.03
bwave_milc	1.039	78.59	66.49
wrf_bwave	1.011	56.36	43.85
cactus_namd	1.008	36.28	24.48
libq_omnetpp	1.055	26.57	20.89
Average	1.021	43.26	35.67

In our evaluation, we use 32-bit timestamps to keep the area overhead low. Thus, there is an additional 32 bits per 64-byte cache line. The number of bits used for the timestamp counter has an impact on the frequency of timestamp rollover and is a parameter that can be controlled. Timestamp rollover results in extra misses due to unnecessary *sbit* resets to retain correctness, which can result in performance loss.

An *sbit* is required per hardware context that shares the cache for each cache line. The total number of *sbits* can be significant for the LLC in server-class processors. In order to keep the number of *sbits* low, design principles used for coherence directories could be applied, for example, limited pointers [2]. The limited pointer [2] directory design work demonstrated empirically that applications typically share data across a few processors. Since pointers require $\log(n)$ bits (for n hardware contexts), keeping track of a limited number of sharers would reduce area overhead to $O(\log(n))$ as opposed to n bits per cache line.

5.4. *sbits* Save and Restore Overhead

When a process is resumed, the *sbits* and the Ts that were saved for the process at the time of preemption must be restored. The overhead due to copying the *sbits* is low for small cache sizes. The entire *sbit* array for an L1 cache of size 64KB can be copied in 2 64-byte cache-line-size memory accesses. The overhead scales with the size of the cache. The copy can take 256 memory accesses for a last-level cache of size 8MB. The *sbits* can be read and written in parallel via the 'regular' bit-line interface when a save or restore is required at a context switch. The save and restore is done to and from a kernel memory region reserved for the *sbits*, to which the process context points.

TABLE 3: *sbit* size relative to the cache size

cache size (B)	sbits	accesses
64	1bit	1
64K	128B	2
256K	512B	8
8M	16KB	256

On an Intel i7-7700 processor operating at 3.6Ghz, the time to copy *sbits* for an 8MB size cache *without* caching is $2.4 \mu s$. This is of comparable magnitude to a null context switch or system call. A typical process time slice varies from 1 ms to several ms, so the $2.4 \mu s$ overhead is at most

0.24% of the process run-time. An extra layer of buffering in hardware could allow the copy to be performed in parallel with the execution of the next process.

6. Related Work

Existing solutions for protecting against cache side channel attacks that exploit shared libraries either resort to cache partitioning or remove timing information from the accesses. Both approaches incur significant overhead.

6.1. Dynamic Cache Partitioning

Statically partitioning caches causes significant performance deterioration as some parts of the cache become unavailable to other processes [22], whereas dynamic cache partitioning can achieve lower overheads by reallocating space as needed. SecDCP [29] is one such dynamic partitioning technique, which broadly categorizes applications as either 'confidential' or 'public' and prevents any information leakage from confidential applications to public applications, but allows information flow in the other direction. Although this dynamic cache partitioning technique performs better than its static counterpart, it provides a very coarse-grained security classification [29]. Another dynamic cache partitioning technique utilizes page coloring to allocate pages to a secure domain [27], [33], but may incur significant copy costs for recoloring.

6.2. Using Intel CAT-based Partitioning

Both Catalyst [20] and Apparition [7] have demonstrated the use of Intel's cache allocation technology (CAT) to achieve cache partitioning for mitigating cache side channels. Both Apparition and Catalyst disallow or do not protect against attacks using shared software. The performance of the systems depend on their ability to reassign caches to different applications and keep cache flushes to a minimum. Apparition [7] uses one Class of Service (CLOS) per application and flushes it across context switches. Catalyst uses pinned pages to provide a solution suited to cloud service providers. This defense mechanism is suited to prevent cross-VM attacks and attacks targeted at the LLC, and is not suited to higher-level caches. The design further requires manually tagging pages that should be pinned or need to remain secure.

6.3. Removing Time & Constant Time Algorithm

The ability to time data accesses precisely can also be seen as the cause for side channel exploits. Taking this ability away from untrusted applications is not sufficient to prevent the attacks. There are several new techniques to obtain timestamps in up to microsecond granularity. These methods provide alternate timing primitives or recovery of clock resolution [25] on systems that obfuscate time by reducing the clock resolution.

Figure 8: Sensitivity Analysis

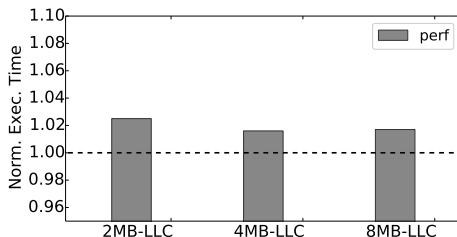

Other approaches to mitigating side channels in shared memory suggest program transformation for constant time implementation. These program transformations have impractical overhead due to making each critical access $O(n)$ [9] and are not useful for large shared libraries.

7. Discussion

Sharing software is an important component of computing systems for efficiency and consistency. This work eliminates a channel for the leak of secret data via monitoring a victim’s access to shared content using shared caches. In the absence of shared content, shared caches still allow a victim’s access behavior to be monitored, but the information channel is far less accurate. In particular, a “Prime+Probe” attack fills (primes) an entire cache set, and infers the cache set accessed by the victim, based on whether the attacker’s probe hits or misses. Proposed defenses for a “Prime+Probe” attack include a randomizing cache [24] [19]. These defenses do not work for attacks against shared content, which provides a more accurate/less noisy channel of information. Our solution in conjunction with these defenses can provide a more complete defense.

Other approaches to defending against more recent attacks like Spectre either stall execution, or make speculative instructions invisible to succeeding load requests [30] [16]. They do not prevent non-speculative cache side channels. Speculative side channel attacks rely on conventional side channels for leaking speculatively loaded data to the attacker, i.e., the means of data leak is conventional side channels. Breaking conventional cache attacks, we also prevent speculative side channel leaks.

8. Conclusion

We have designed and evaluated a timestamp-based defense against timing side channel attacks that rely on fast reload of shared memory in caches to learn secret information. Our design prevents attacks from cross-core, same core, or SMT contexts, and at any level of cache, without the need for cache partitioning. To perform timestamp comparisons in parallel, we designed a hardware SRAM array that allows bit-serial, timestamp-parallel comparison with easy transposed access. We have evaluated the defense against microbenchmark attack programs and the classic flush+reload attack using the GEM5 simulator. On SPEC2006 benchmarks that create multiple processes, the performance overhead due to delaying the first accesses is 2.17% on average, and copying process-specific *sbits* adds at most 0.24% even when there is a context switch every millisecond. Our defense against timing side channels through shared software retains the benefits of allowing processes to utilize the entire cache capacity of a shared cache and allows cache and memory pressure reduction through data deduplication.

9. Acknowledgements

This work was supported in part by National Science Foundation (NSF) Awards CNS-1618497 and CNS-1900803. We thank Sreepathi Pai for his feedback during early discussions of the ideas in this paper.

References

- [1] Kernel samepage merging (memory deduplication). https://kernelnewbies.org/Linux_2_6_32#Kernel_Samepage_Merging_28memory_deduplication.29, 2017.
- [2] A. Agarwal, R. Simoni, J. Hennessy, and M. Horowitz. An evaluation of directory schemes for cache coherence. In *International Symposium on Computer Architecture (ISCA)*, pages 280–289, June 1988.
- [3] Kenneth E. Batcher. Bit-serial parallel processing systems. *IEEE Transactions on Computers*, (5):377–384, 1982.
- [4] Nathan Binkert, Bradford Beckmann, Gabriel Black, Steven K. Reinhardt, Ali Saidi, Arkaprava Basu, Joel Hestness, Derek R. Hower, Tushar Krishna, Somayeh Sardashti, Rathijit Sen, Korey Sewell, Muhammad Shoab, Nilay Vaish, Mark D. Hill, and David A. Wood. The gem5 simulator. *SIGARCH Comput. Archit. News*, 39(2):1–7, August 2011.
- [5] Guoxing Chen, Sanchuan Chen, Yuan Xiao, Yinqian Zhang, Zhiqiang Lin, and Ten H Lai. Sgxpectre attacks: Stealing intel secrets from sgx enclaves via speculative execution. *arXiv preprint arXiv:1802.09085*, 2018.
- [6] Craig Disselkoen, David Kohlbrenner, Leo Porter, and Dean Tullsen. Prime+ abort: A timer-free high-precision l3 cache attack using intel {TSX}. In *26th {USENIX} Security Symposium ({USENIX} Security 17)*, pages 51–67, 2017.
- [7] Xiaowan Dong, Zhuojia Shen, John Criswell, Alan L Cox, and Sandhya Dwarkadas. Shielding software from privileged side-channel attacks. In *27th {USENIX} Security Symposium ({USENIX} Security 18)*, pages 1441–1458, 2018.
- [8] Charles Eckert, Xiaowei Wang, Jingcheng Wang, Arun Subramaniyan, Ravi Iyer, Dennis Sylvester, David Blaauw, and Reetuparna Das. Neural cache: Bit-serial in-cache acceleration of deep neural networks. In *Proceedings of the 45th Annual International Symposium on Computer Architecture*, pages 383–396. IEEE Press, 2018.
- [9] Oded Goldreich and Rafail Ostrovsky. Software protection and simulation on oblivious rams. *Journal of the ACM (JACM)*, 43(3):431–473, 1996.
- [10] Daniel Gruss, Clémentine Maurice, Klaus Wagner, and Stefan Mangard. Flush+ flush: a fast and stealthy cache attack. In *International Conference on Detection of Intrusions and Malware, and Vulnerability Assessment*, pages 279–299. Springer, 2016.
- [11] Daniel Gruss, Raphael Spreitzer, and Stefan Mangard. Cache template attacks: Automating attacks on inclusive last-level caches. In *24th {USENIX} Security Symposium ({USENIX} Security 15)*, pages 897–912, 2015.
- [12] David Gullasch, Endre Bangerter, and Stephan Krenn. Cache games—bringing access-based cache attacks on aes to practice. In *2011 IEEE Symposium on Security and Privacy*, pages 490–505. IEEE, 2011.
- [13] Andrew Herdrich, Edwin Verplanke, Priya Autee, Ramesh Illikkal, Chris Gianos, Ronak Singhal, and Ravi Iyer. Cache qos: From concept to reality in the intel® xeon® processor e5-2600 v3 product family. In *2016 IEEE International Symposium on High Performance Computer Architecture (HPCA)*, pages 657–668. IEEE, 2016.
- [14] Wei-Ming Hu. Lattice scheduling and covert channels. In *Proceedings 1992 IEEE Computer Society Symposium on Research in Security and Privacy*, page 52. IEEE, 1992.

- [15] Keren Jin and Ethan L. Miller. The effectiveness of deduplication on virtual machine disk images. In *Proceedings of SYSTOR 2009: The Israeli Experimental Systems Conference*, SYSTOR 09, New York, NY, USA, 2009. Association for Computing Machinery.
- [16] Khaled N Khasawneh, Esmail Mohammadian Koruyeh, Chengyu Song, Dmitry Evtushkin, Dmitry Ponomarev, and Nael Abu-Ghazaleh. Safespec: Banishing the spectre of a meltdown with leakage-free speculation. *arXiv preprint arXiv:1806.05179*, 2018.
- [17] Paul Kocher, Daniel Genkin, Daniel Gruss, Werner Haas, Mike Hamburg, Moritz Lipp, Stefan Mangard, Thomas Prescher, Michael Schwarz, and Yuval Yarom. Spectre attacks: Exploiting speculative execution. *arXiv preprint arXiv:1801.01203*, 2018.
- [18] Esmail Mohammadian Koruyeh, Khaled N. Khasawneh, Chengyu Song, and Nael Abu-Ghazaleh. Spectre returns! speculation attacks using the return stack buffer. In *12th USENIX Workshop on Offensive Technologies (WOOT 18)*, Baltimore, MD, August 2018. USENIX Association.
- [19] F. Liu, H. Wu, K. Mai, and R. B. Lee. Newcache: Secure cache architecture thwarting cache side-channel attacks. *IEEE Micro*, 36(5):8–16, Sep. 2016.
- [20] Fangfei Liu, Qian Ge, Yuval Yarom, Frank Mckeen, Carlos Rozas, Gernot Heiser, and Ruby B Lee. Catalyst: Defeating last-level cache side channel attacks in cloud computing. In *2016 IEEE international symposium on high performance computer architecture (HPCA)*, pages 406–418. IEEE, 2016.
- [21] Fangfei Liu, Yuval Yarom, Qian Ge, Gernot Heiser, and Ruby B Lee. Last-level cache side-channel attacks are practical. In *2015 IEEE Symposium on Security and Privacy*, pages 605–622. IEEE, 2015.
- [22] D Page. Partitioned cache architecture as a side-channel defence mechanism. 2005.
- [23] Moinuddin K Qureshi. Ceaser: Mitigating conflict-based cache attacks via encrypted-address and remapping. In *2018 51st Annual IEEE/ACM International Symposium on Microarchitecture (MICRO)*, pages 775–787. IEEE, 2018.
- [24] Moinuddin K Qureshi. New attacks and defense for encrypted-address cache. In *Proceedings of the 46th International Symposium on Computer Architecture*, pages 360–371. ACM, 2019.
- [25] Michael Schwarz, Clémentine Maurice, Daniel Gruss, and Stefan Mangard. Fantastic timers and where to find them: high-resolution microarchitectural attacks in javascript. In *International Conference on Financial Cryptography and Data Security*, pages 247–267. Springer, 2017.
- [26] Michael Schwarz, Martin Schwarzl, Moritz Lipp, Jon Masters, and Daniel Gruss. Netspectre: Read arbitrary memory over network. In *European Symposium on Research in Computer Security*, pages 279–299. Springer, 2019.
- [27] Jicheng Shi, Xiang Song, Haibo Chen, and Binyu Zang. Limiting cache-based side-channel in multi-tenant cloud using dynamic page coloring. In *2011 IEEE/IFIP 41st International Conference on Dependable Systems and Networks Workshops (DSN-W)*, pages 194–199. IEEE, 2011.
- [28] Daimeng Wang, Ajaya Neupane, Zhiyun Qian, Nael B Abu-Ghazaleh, Srikanth V Krishnamurthy, Edward JM Colbert, and Paul Yu. Unveiling your keystrokes: A cache-based side-channel attack on graphics libraries. In *NDSS*, 2019.
- [29] Yao Wang, Andrew Ferraiuolo, Danfeng Zhang, Andrew C Myers, and G Edward Suh. Secdcp: secure dynamic cache partitioning for efficient timing channel protection. In *Proceedings of the 53rd Annual Design Automation Conference*, page 74. ACM, 2016.
- [30] Mengjia Yan, Jiho Choi, Dimitrios Skarlatos, Adam Morrison, Christopher Fletcher, and Josep Torrellas. Invisispec: Making speculative execution invisible in the cache hierarchy. In *2018 51st Annual IEEE/ACM International Symposium on Microarchitecture (MICRO)*, pages 428–441. IEEE, 2018.
- [31] Mengjia Yan, Bhargava Gopireddy, Thomas Shull, and Josep Torrellas. Secure hierarchy-aware cache replacement policy (sharp): Defending against cache-based side channel attacks. In *2017 ACM/IEEE 44th Annual International Symposium on Computer Architecture (ISCA)*, pages 347–360. IEEE, 2017.
- [32] Yuval Yarom and Katrina Falkner. Flush+reload: A high resolution, low noise, l3 cache side-channel attack. In *23rd USENIX Security Symposium (USENIX Security 14)*, pages 719–732, San Diego, CA, August 2014. USENIX Association.
- [33] Xiao Zhang, Sandhya Dwarkadas, and Kai Shen. Towards practical page coloring-based multicore cache management. In *Proceedings of the 4th ACM European conference on Computer systems*, pages 89–102. ACM, 2009.
- [34] Yinqian Zhang, Ari Juels, Michael K. Reiter, and Thomas Ristenpart. Cross-tenant side-channel attacks in paas clouds. In *Proceedings of the 2014 ACM SIGSAC Conference on Computer and Communications Security, CCS 14*, page 9901003, New York, NY, USA, 2014. Association for Computing Machinery.